

2

1

NOTES:

- 1. MATERIAL: FIBERGLASS REINFORCED POLYMER (FRP)
- 2. WEIGHT: 6 Lbs.
- 3. INSIDE DIAMETER: 5 7/8"
- 4. OUTSIDE DIAMETER: 7 3/8"

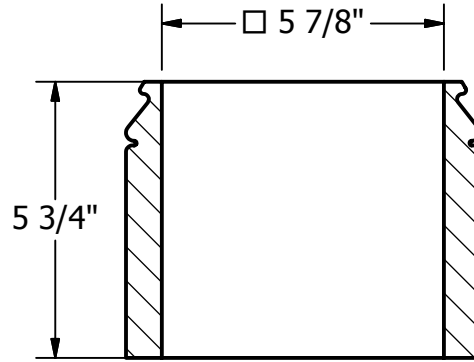
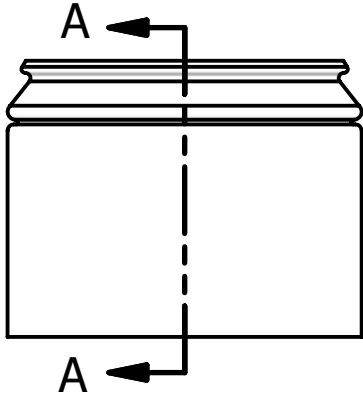
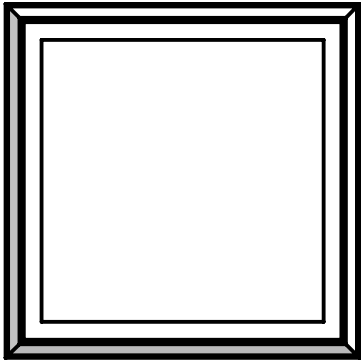

SECTION A-A

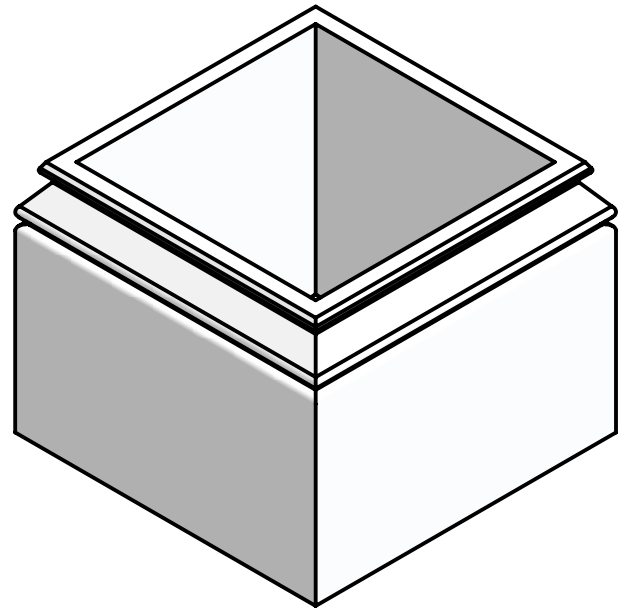
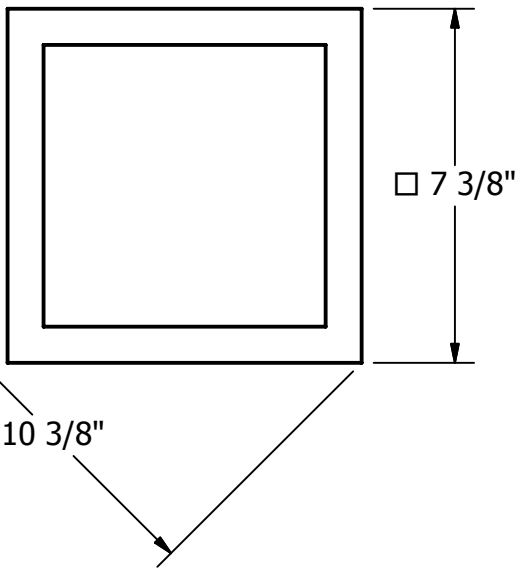

NOT TO SCALE

DRAWN	Bryan Daniels	4/18/2016
CHECKED		
QA		
MFG		
APPROVED		



TITLE
Alto Base 6 Inch

DIMENSIONS ARE IN INCHES
TOLERANCE: ± 1/4"

SIZE A	DWG NO	SQAB5606	REV	03
SCALE	1:4	SHEET 1 OF 1		

2

1