

REV.	DESCRIPTION	DATE
A	Replaced staves with profile # 94256	04-26-2016

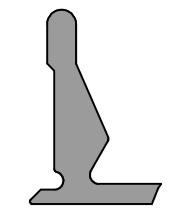

DETAIL A
SCALE 3 : 1

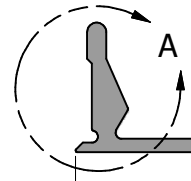
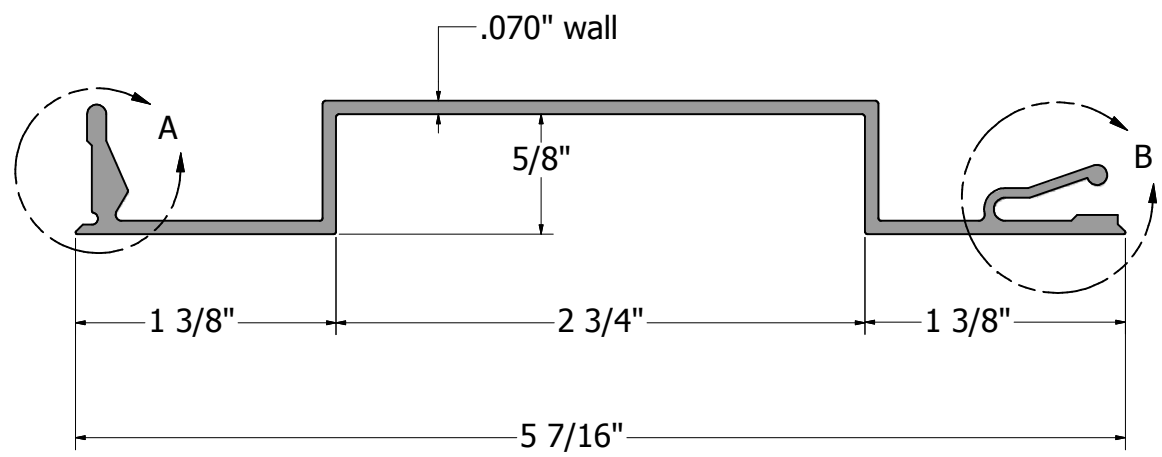
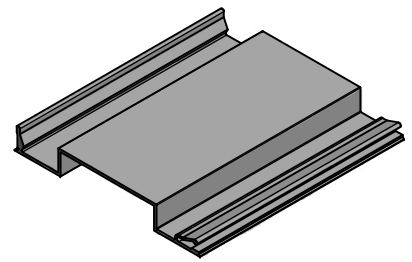
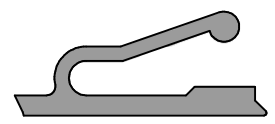
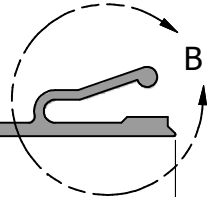

DETAIL B
SCALE 3 : 1

Length	Part Number
8 feet	55855
9 feet	55856
10 feet	55857

 <p>DSI Digger Specialties Inc. 3446 US 6 EAST BREMEN, IN 46506 www.diggerspecialties.com</p>	WEIGHT: .705 lbs./ft	DRAWN BY: WJM	MATERIAL: Aluminum	
	STANDARD TOLERANCE: .00 ~.01 .000 ~.005 ANG. ~.5~	DATE DRAWN: 2/16/2012		PART NAME: 6in.Alum Stave Sq. Recessed.idw
	FRACTIONS: ± 1/16"	DRAFT NO. 20120216-1	PART NUMBER: See Chart	REV. A
	FILE LOC: Z:\Aluminum\DSI Columns\Sq. Recessed Columns\6 Inch\6in.Alum Stave Sq. Recessed.idw			