

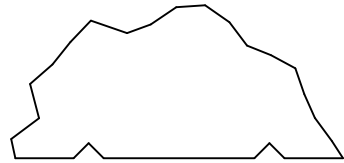

REV.	DESCRIPTION	DATE

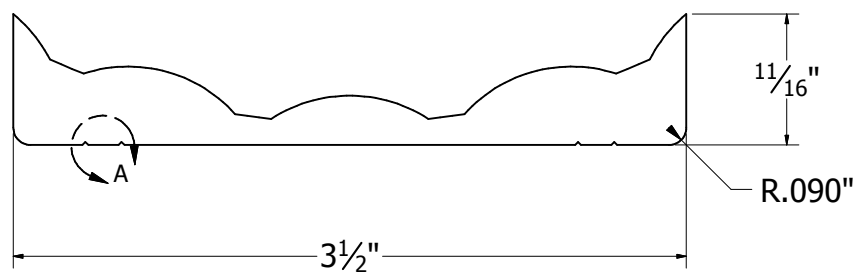

DETAIL A
SCALE 10

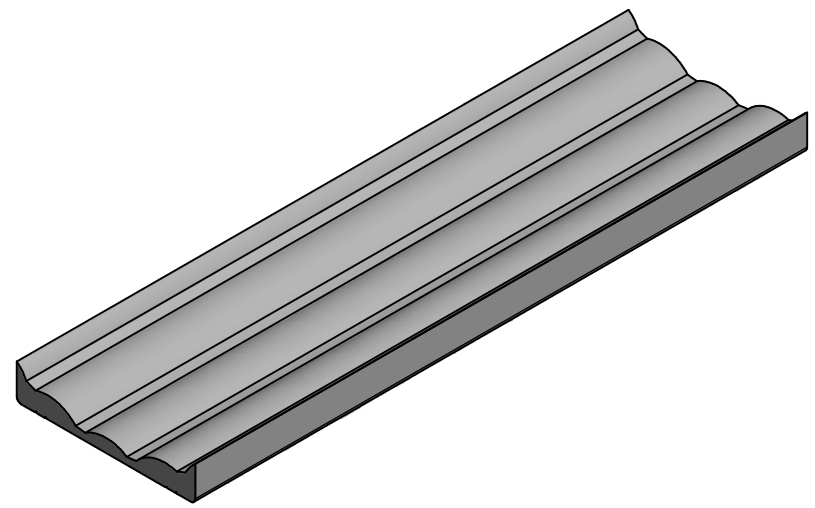

 DSI Digger Specialties Inc. 3446 US 6 EAST BREMEN, IN 46506 www.diggerspecialties.com	WEIGHT: 1.375 lbs/ft.	DRAWN BY: WJM	MATERIAL: Aluminum
	STANDARD TOLERANCE: .00 .01 .000 .005 ANG. .5~	DATE DRAWN: 11/29/2012	PART NAME: 55889 8in Rnd Fluted Adaptor.idw
	FRACTIONS: ± 1/16"	DRAFT NO. 20121129-4W	PART NUMBER: 55889
	FILE LOC: Z:\Aluminum\DSI Columns\Rnd Fluted Columns\8 Inch\Railing App\55889 8in Rnd Fluted Adaptor.idw		REV.