

# Tuscany Series & Montego Series

(Style C10, C101 and C20)

## Installation Instructions



- These instructions must be followed exactly as written and the materials used must be exactly as shown in the instructions. Any deviation from the instructions or variation in the materials used/installed may result in an unsuccessful installation.
- When core drilling any post product where water can build up, the installer is responsible to drill a 1/4" hole as close to the bottom of the post by concrete as possible. If there is no weep hole, you may have damage from moisture build up and freezing thus potentially voiding the powder coating warranty.

### Installing Alum. Post w/ Adjustable Plate

NOTE: The installer is responsible to have the substructure strong enough to support the post for what it is rated.

1. Place the (2) stainless steel strips below the plate under the leveling bolts.
2. **For concrete installation**, fasten aluminum post to concrete using (4) 3/8" x 3" or longer concrete anchors (anchors not included.)

**For IRC wood surface installation:** attach wood blocking to substructure with #10 x 3" wood screws. Fasten aluminum post using (4) 3/8" x 5-1/2" bolts (anchors not included) thru aluminum backer plate (sold separately) as shown below.

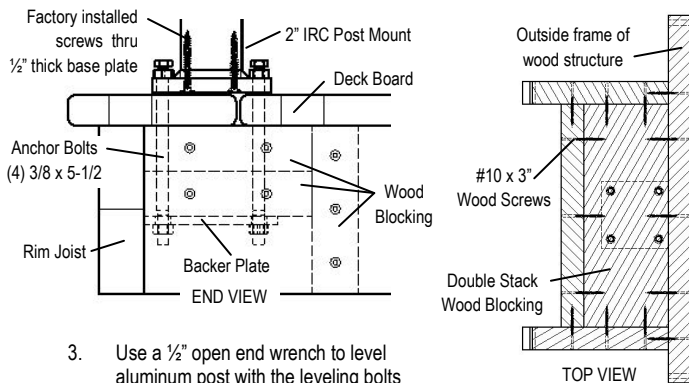

3. Use a 1/2" open end wrench to level aluminum post with the leveling bolts on the welded plate.
4. Attach caps. Lightly tap with rubber mallet if needed.

### Angle (Swivel) Mount

1.
  - a. Position bottom swivel mount base so the bottom of the rail has no more than a 2" clearance. *NOTE: A 1 5/8" spacer may be placed on the welded 3/8" plate of the post to reach the 2" clearance. 1 1/4" spacer for 1/2" plate.*
  - b. Measure up 32 5/8" (for 36" tall railing) or 38 5/8" (for 42" tall railing) from top of bottom mount to top of top mount.
2. Keeping base of mount centered and pin hole turned down, fasten base to post with pan head self-tapping screws (provided).
3. Angle the swivel mount after it is installed on post. Measure from back of cup at one end to back of cup at other end to determine rail length. Cut rails.
4. Assemble sections as specified in Standard (Level) railing steps 4-7.

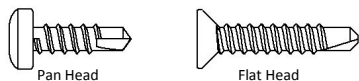

### Standard (Level) Railing

Note: Top rail is 1" longer on each end to accommodate Crossover railing

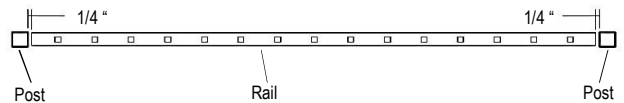

1. Cut the rails to length by holding rails against posts. Position so there will be the same baluster spacing on each end of the rails **if possible**. Mark rails where they are to be cut. **Make sure rail is cut 1/4" shorter on each end to allow for mounts.** Cut rails.

**Crossover railing-** Cut bottom rail same as above. For top rail, make end spacing exactly 1" longer on all ends connecting to the crossover post.

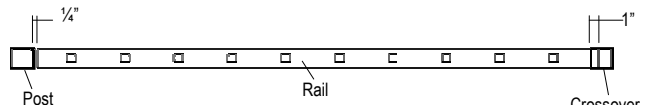

2. Attach bottom wall mount to post by positioning the bottom rail so there is no more than 2" clearance. Keeping mount centered on post, fasten mount to post with pan head self-tapping screws (provided). A 1-3/8" spacer may be placed on the welded 3/8" plate of the post to reach the 2" clearance. Use a 1-1/4" spacer for posts with 1/2" plate.
3. Attach top wall mount to post by measuring up 32-5/8" (for 36" tall railing) or 38-5/8" (for 42" tall railing) from the top of the bottom mount to the top of the top mount. Keeping mount centered on post, fasten mount to post with self-tapping pan head screws (provided).
4. Fasten rail support to bottom side of bottom rail by inserting pan head self-tapping screw (provided) through center of threaded portion of support. This applies to all sections over 6ft long.
5. Place bottom rail in mounts and fasten with flat head self-tapping screws provided. On sections without a rail support, place a 2" block under the bottom rail before inserting balusters. Using a rubber mallet, tap balusters into routed holes making sure balusters are seated all the way into the rail. Hold top rail at an angle above the balusters. Align with mounts. Starting at one end, feed first baluster into rail and tap lightly. Feed remaining seated balusters into rail, tapping lightly as you move to the other end making sure all balusters are against the top rib. Fasten top rail through side of mount with flat head screw provided. **Crossover railing-** Fasten top rail to crossover adaptor with pan head screws provided.
6. Snap covers on all mounts.
7. Attach 2 piece flair to all posts.

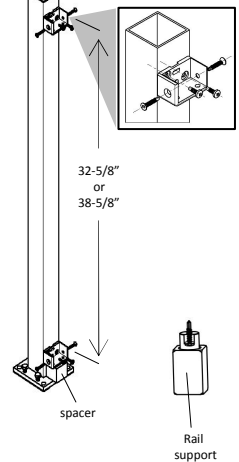

# Tuscany Series & Montego Series

(Style C10, C101 and C20)

## Installation Instructions



- These instructions must be followed exactly as written and the materials used must be exactly as shown in the instructions. Any deviation from the instructions or variation in the materials used/installed may result in an unsuccessful installation.
- When core drilling any post product where water can build up, the installer is responsible to drill a 1/4" hole as close to the bottom of the post by concrete as possible. If there is no weep hole, you may have damage from moisture build up and freezing thus potentially voiding the powder coating warranty.

### Stair Railing

**Important: Rails have to be positioned in the correct direction prior to cutting. If rails are not in the correct position they may be cut incorrectly and balusters will not line up. Rails will have a small hole at one end that indicates the lower end of the stairs.**

1. Identify top and bottom stair rails.
2. Lay bottom rail beside posts with approximately 1" clearance (use 1" spacer) between the rail and nose of step. Insert a baluster into the last hole on each end. Place top rail on these balusters.
3. Position rails against posts and even the end spacing on each end, **if possible**, with balusters parallel to the post. Clamp rails to post (Example 1.) Mark rails for cutting. Mark posts for each mount position See (Example 2). Cut rails 3/16" shorter than mark on each end. See (Example 3).
4. **Crossover Railing:** For crossover stairs set stair crossover kit next to rails that are fastened to post to determine what height to cut post. Mark post and cut. Set crossover connector in post and fasten at proper height with self-tapping pan head screws provided. Set correct angle for crossover connector to match railing and tighten nut. Cut bottom rails same as above in step 3 (Example 3). Mark top rails to cut making sure it fits snug into the crossover connector (Example 4).

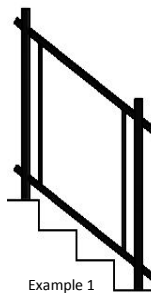

Example 1

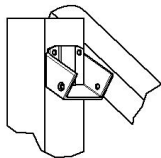

Example 2

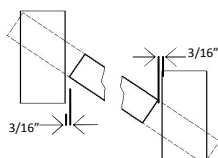

Example 3

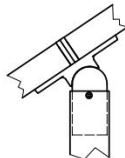

Example 4

5. Attach mounts to post with pan head self-tapping screws (provided). Attach bottom rail to mounts with flat head self-tapping screws (provided).
6. Cut balusters at angle of stairs on both ends. (Overall length of baluster will not change.)
7. Insert balusters into bottom rail. Seat completely into bottom rail by tapping with rubber mallet.
8. Hold top rail at an angle above balusters. Insert balusters into top rail starting at the top end and working towards the bottom of the stairs. Tap lightly with rubber mallet making sure the balusters are fully seated into top rail.
9. Attach top rail to mounts by inserting flat head self-tapping screws (provided) through the side of the mounts. Lightly tap mount covers onto mounts. (Use caution when installing covers by applying pressure directly on top of the cover tab.)
10. Attach 2-piece flairs to all posts.

### Swivel Stair Mount

1. Identify top and bottom rails, top swivel mount and bottom swivel mount.
2. Lay bottom rail (with approximately 1" clearance from the nose of the steps) beside the posts. Determine where the end holes will be on each end and place a baluster in those holes. Place top rail on these balusters. Holding rails against posts, determine end spacing making sure end spacing is even between post and balusters. Clamp rails to post (Example 1). Hold swivel stair mounts up against posts and beside the rail to determine where rails are to be cut to fit inside the swivel stair mounts. Mark posts for each stair swivel mount position (Example 5). NOTE: This will vary depending on angle of stairs. Cut rails. Cut top rail at same length as bottom rail unless using crossover application.
3. Attach bottom swivel mount base so the bottom rail has approximately 1" clearance from the nose of the step. (NOTE: A 1" spacer may be placed on the nose of the step to reach the 1" clearance.) Fasten base to post with pan head self-tapping screws (provided).
4. Attach top swivel mount base to post using pan head self-tapping screws (provided).
5. Attach bottom rail to bracket using flat head self-tapping screws (provided) on each side of rail.
6. Follow Stair Railing steps 6-9 for assembly of section.
7. Attach top rail to bracket using flat head self-tapping screws (provided) on each side of rail.
8. Attach 2-piece flairs to all posts.

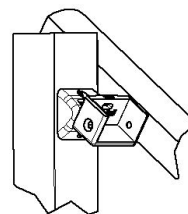

Example 5

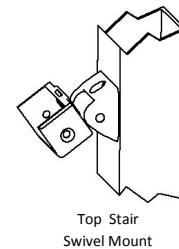

Top Stair Swivel Mount

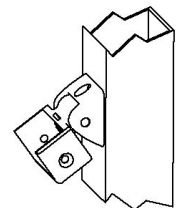

Bottom Stair Swivel Mount

Video Installation Instructions on  
YouTube

Scan the link or visit  
[www.youtube.com/diggerspecialtiesinc](http://www.youtube.com/diggerspecialtiesinc)

